

Transport Refrigeration



Table of Contents

Daikin	3	Light Truck	23
Zanotti	4	SFZ	
Cold Chain – Integrated	5	SFZ238	24
Product Portfolio	6	SFZ248	24
Van – Direct-Drive	9	SFZ238 Multi	26
Invisible Direct-Drive		SFZ248 Multi	26
SFZ007	10	Truck	27
SFZ008	10	Uno	
SFZ009	10	U600	28
SFZ009 Multi	10	U800	28
Zero Direct-Drive		U1000	28
Z200	12	U800 Multi	30
Z250	12	U1000 Multi	30
Z350	12	Uno Undermount	
Z380	12	UN120	32
Z380 Multi	14	UN120 Multi	32
Van – Electric	15	Services and Aftermarket	33
Invisible Electric		Service Network	34
SFZ009e	16	Telematics	34
SFZ009e Multi	16	Genuine Parts	35
Zero Electric		Extended Warranty	35
Z120b	18	Home Delivery Solutions	36
Z200e	20	Pharma Solutions	37
Z250e	20	Future of Daikin Transport Refrigeration	38
Z350e	20		
Z350e Multi	20		



Daikin

Daikin Europe N.V., founded in 1973 in Ostend, Belgium, is a major European producer of air conditioners, heating systems, and refrigeration equipment. Daikin employs over 8000 people throughout Europe and have manufacturing facilities in Belgium, Germany, Austria, Italy, UK, Czechia, and Turkey. Daikin Group is world-renowned for its pioneering approach to product development and the unrivalled quality and versatility of its integrated solutions.

Refrigeration Expertise

Daikin, together with its family of companies including Zanotti, Hubbard, Tewis, and AHT, has the widest range of products integrating commercial, industrial and transport refrigeration needs across Europe. Daikin group companies strive to achieve the highest levels of quality, innovation and sustainability.



Daikin Reefer offers unrivalled reliability in marine transport refrigeration while initiating a new era with the Active Controlled Atmosphere technology.

Environmental Vision 2050

In the spirit of the Paris Agreement, Daikin formulated the Environmental Vision 2050, a new sustainable business roadmap with a target of reducing its greenhouse gas emissions to net-zero by mid-century. Guided by this vision, Daikin Europe innovates to improve the environmental footprint of its products and operations, meeting and exceeding global, European and local legislative requirements. As a leader in environmental sustainability, the company promoted continuous performance improvements to preserve the efficiency and integrity of its cold chain.



Daikin Chemicals manufacture fluorochemical products, including low GWP refrigerants in line with Daikin's Environmental Vision 2050.



Zanotti

Zanotti is a refrigeration specialist founded in 1962, serving the needs of commercial, industrial, and transport refrigeration industries. Zanotti is headquartered in Mantua, Italy, in a state-of-the-art manufacturing facility with 600 employees, and continues investing at the site, expanding production and testing.

Zanotti has made a name for itself in Europe by addressing unmet customers needs in short-distance transport with its market-leading van and truck refrigeration units. This focus on urban transport, including home delivery and pharma segments, resulted in unique offerings such as the Invisible Multi and a customer-centric approach with tailor-made product configurations.

Zanotti's mission is to become the customers' top choice in road transport refrigeration across the entire range of vehicles and applications. The 2016 acquisition of Zanotti by Daikin Europe transformed this vision into reality by combining Zanotti's refrigeration expertise with Daikin's unparalleled design and manufacturing capabilities, and extensive sales and service network.



Cold Chain – Integrated

Zanotti's decades of refrigeration expertise, combined with Daikin's unparalleled design and manufacturing capabilities, and extensive sales and service network, has delivered an integrated cold chain solution across Europe, covering all refrigeration needs from farm to fork.

Together with Zanotti, we aim to re-shape the road transport refrigeration industry by keeping sustainability and customer-centricity at the forefront of our business model across Europe and the world. We strive to meet diverse customer needs with our comprehensive portfolio of products and services, linked to flexible tailor-made solutions that incorporate Daikin's world-renowned reliability and innovation.

Our family of companies is integrated in cold chain, uniquely positioned to make a positive impact, addressing global challenges such as climate change, and ensuring a safe and sustainable supply of food and pharmaceutical products.

The synergy generated by combining Daikin's market-leading technologies and extensive footprint with Zanotti's transport refrigeration heritage enables us to deliver the optimal solution for our customers.

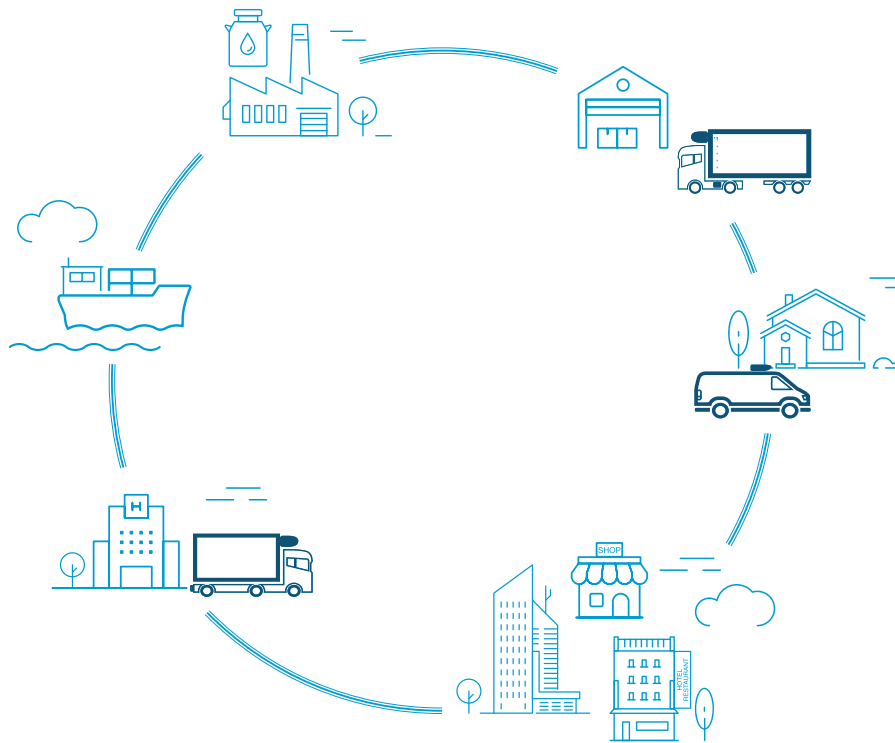

Sustainable and Innovative Solutions

- › Collaboration with Daikin Chemicals to introduce safe, low-GWP refrigerants
- › Reduced transport carbon emissions via alternative power technologies
- › Cutting-edge Refrigeration Technology Innovation Centre

Customer-Centric Approach





- › Daikin product design and production systems ensure the highest reliability standards for the customers' peace of mind
- › Smart design decisions eliminate serviceable parts and extend service intervals to minimise your running costs and total cost of ownership
- › Tailor-made configurations that exactly meet customer needs in the ever-changing world of transport







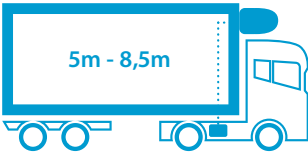

Comprehensive Service & Support

- › International service network available 24/7
- › Unparalleled customer care that is here to stay
- › Global sales, distribution, and manufacturing networks

Product Portfolio

Our transport refrigeration unit range offers reliable and efficient solutions for a wide range of applications and vehicle types. Each unit is designed to minimize your total cost of ownership, configured to your exact needs, manufactured to Daikin's rigorous quality standards, and supported with a service network available 24/7.

VAN			
Direct-Drive		Electric	
Invisible Direct-Drive	Zero Direct-Drive	Invisible Electric	Zero Electric
			
			
SFZ007 SFZ008 SFZ009	Z200 Z250 Z350 Z380	SFZ009e	Z120b Z200e Z250e Z350e
			
SFZ009 Multi	Z380 Multi	SFZ009e Multi	Z350e Multi

LIGHT TRUCK	TRUCK	
SFZ	Uno	Uno Undermount
		
		
<p>SFZ238 SFZ248</p>	<p>U600 U800 U1000</p>	<p>UN120</p>
		
<p>SFZ238 Multi SFZ248 Multi</p>	<p>U800 Multi U1000 Multi</p>	<p>UN120 Multi</p>





Van

Direct-Drive





Invisible Direct-Drive

SFZ007 | SFZ008 | SFZ009 | SFZ009 Multi

Our Invisible range is designed for discreet and efficient transportation of refrigerated products in vans. These units are installed underneath the vehicle chassis, completely invisible from the outside, preserving the aesthetics, original height and aerodynamics of the vehicle, while reducing bodywork. SFZ007, SFZ008 and SFZ009 offer varying refrigeration capacities and volume ratings tuned for different applications. SFZ009 Multi features dual evaporators to enable products with different temperature requirements to be transported in two separate zones.

The Invisible range, with its ultra-thin dimensions make it the ideal choice for customers who need a space-saving solution. A driver-friendly interface in the cabin allows real-time monitoring and control of the unit performance to ensure the cargo is maintained at precisely the right temperature throughout the trip.

Key Features:

- ✓ Multiple temperature zones in the same vehicle (Multi model only)
- ✓ Powered by direct-drive on road, electric grid on stand-by
- ✓ Vehicle access to tight underground areas
- ✓ Under-chassis mounting preserves vehicle aesthetics and aerodynamics
- ✓ Invisible from the outside
- ✓ Low noise
- ✓ User-friendly cabin driver interface
- ✓ Telematics-compatible
- ✓ 2-year standard warranty





		SFZ007	SFZ008	SFZ009	SFZ009 Multi				
General									
Refrigerant	[-]	R134a		R452A					
System net cooling capacity under ATP conditions (30°C ambient temperature)									
	[°C]	0°C	-20°C	0°C	-20°C	0°C	-20°C	0°C	-20°C
Road mode	[W]	1790	N/A	2180	1090	3250	1710	2990	1580
Stand-by mode	[W]	1130	N/A	1580	800	1900	1050	1760	970
Heating capacity									
Road mode	[W]	N/A		1890		2790		2640	
Stand-by mode	[W]	N/A		1380		1630		1580	
Airflow rate									
Airflow rate at 100kPa static pressure	[m ³ /h]	620		910		840		2x 620	
Weight									
Condenser without electric stand-by	[kg]	25		38		45		45	
Condenser with electric stand-by	[kg]	50		65		75		75	
Evaporator	[kg]	10		14		20,5		2x 10,2	
Road compressor									
Displacement	[cc]	146		146		163		163	

These products contain fluorinated greenhouse gases (R134a GWP=1430 / R452A GWP=2140,5).

Stand-by voltages available: 230/1/50 or 400/3/50

Vehicle voltages available: 12VDC or 24VDC

Provisional engineering data



Zero Direct-Drive

Z200 | Z250 | Z350 | Z380

The Zero range meets the needs of the distribution industry by offering the utmost flexibility in the temperature management of refrigerated products. The extensive direct-drive Zero line-up including Z200, Z250, Z350, and Z380 is designed to meet a wide range of applications in light commercial vehicles.

All Zero models provide easy installation and serviceability. The condensing unit can be mounted on the roof or the front wall of the box, and the ultra-thin evaporator installed in the cargo compartment maximizes cargo volume. A driver-friendly interface in the cabin allows real-time monitoring and control of unit performance to ensure goods are maintained at precisely the right temperature throughout the trip. Our Zero units are setting new standards with their attractive design.

Key Features:

- ✓ Proven reliability and performance
- ✓ Powered by direct-drive on road, electric grid on stand-by
- ✓ Easy to install and service with removable side panels
- ✓ Configurable for a wide range of refrigerated applications in light commercial vehicles
- ✓ Low noise
- ✓ User-friendly cabin driver interface
- ✓ Reduced refrigerant charge and maintenance costs
- ✓ Telematics-compatible
- ✓ 2-year standard warranty



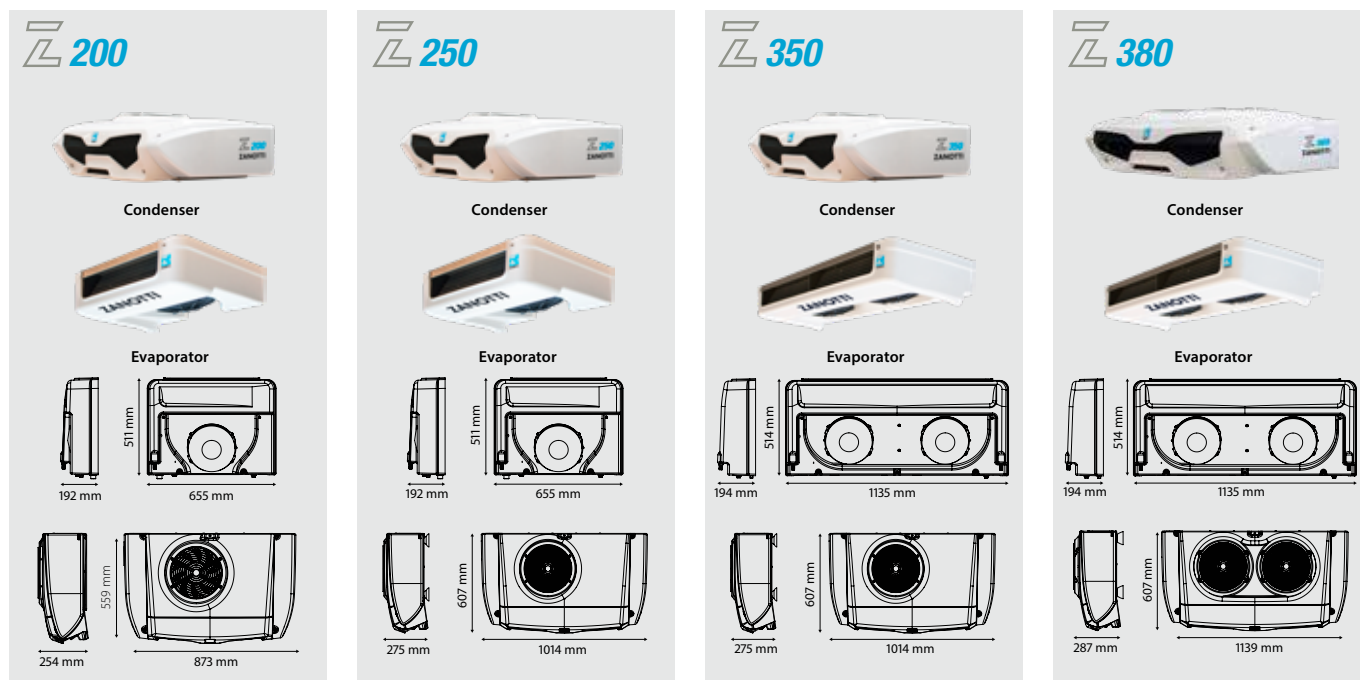

	Z200	Z250	Z350	Z380	Z250	Z380							
General													
Refrigerant	[-]			R452A	R134a								
System net cooling capacity under ATP conditions (30°C ambient temperature)													
	[°C]	0°C	-20°C	0°C	-20°C	0°C	-20°C	0°C	-20°C	0°C	-20°C	0°C	-20°C
Road mode	[W]	2220	1170	2680	1470	3350	1840	3800	2020	2140	N/A	2920	N/A
Stand-by mode	[W]	1500	700	2120	820	2240	890	2450	970	1130	N/A	1900	N/A
Heating capacity													
Road mode	[W]	2100	2500	3100	3300	1930	2620						
Stand-by mode	[W]	1300	1900	2000	2200	1020	1710						
Airflow rate													
Airflow rate at 100kPa static pressure	[m³/h]	622	650	1300	1300	650	1300						
Weight													
Condenser without electric stand-by	[kg]	30	36	36	42	34	40						
Condenser with electric stand-by	[kg]	56	72	72	80	70	78						
Evaporator	[kg]	10,2	10,5	19,6	19,6	9	18						
Road compressor													
Displacement	[cc]	131	131	146	146	146	163						

These products contain fluorinated greenhouse gases (R134a GWP=1430 / R452A GWP=2140,5).

Stand-by voltages available: 230/1/50 or 400/3/50

Vehicle voltages available: 12VDC

Zero Direct-Drive Multi-Temp

Z380 Multi

Z380 Multi and Z380 Multi (Narrow Evap) models are designed to meet the modern needs of low environmental impact refrigeration for light commercial vehicles. These units feature additional evaporators to enable transport of products with different temperature requirements in separate zones, available in multiple configurations to adapt to a wide range of applications.

All Zero models provide easy installation and serviceability. The condensing unit can be mounted on the roof or the front wall of the box, and the ultra-thin evaporator installed in the cargo compartment maximizes cargo volume. A driver-friendly interface in the cabin allows real-time monitoring and control of unit performance to ensure goods are maintained at precisely the right temperature throughout the trip. Our Zero units are setting new standards with their attractive design.

Key Features:

- ✓ Multiple temperature zones in the same vehicle
- ✓ Proven reliability and performance
- ✓ Powered by direct-drive on road, electric grid on stand-by
- ✓ Easy to install and service with removable side panels
- ✓ Configurable for a wide range of refrigerated applications in light commercial vehicles
- ✓ Low noise
- ✓ User-friendly cabin driver interface
- ✓ Reduced refrigerant charge and maintenance costs
- ✓ Telematics-compatible
- ✓ 2-year standard warranty

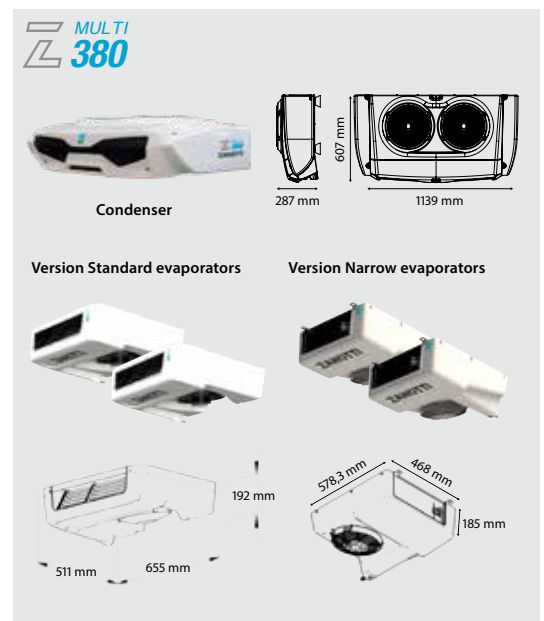

	Z380 Multi		Z380 Multi (Narrow Evap)		
General					
Refrigerant	[-]	R452A			
System net cooling capacity under ATP conditions (30°C ambient temperature)					
	[°C]	0°C	-20°C	0°C	-20°C
Road mode	[W]	3450	1180	3250	1310
Stand-by mode	[W]	2650	920	2420	1030
Heating capacity					
Road mode	[W]	3010		2630	
Stand-by mode	[W]	1770		1520	
Airflow rate					
Airflow rate at 100kPa static pressure	[m ³ /h]	2x 620		2x 830	
Weight					
Condenser without electric stand-by	[kg]	42		42	
Condenser with electric stand-by	[kg]	80		80	
Evaporator	[kg]	2x 10,2		2x 16	
Road compressor					
Displacement	[cc]	146		146	

These products contain fluorinated greenhouse gases (R452A GWP=2140,5).

Stand-by voltages available: 230/1/50 or 400/3/50

Vehicle voltages available: 12VDC

Provisional engineering data

Van Electric





Invisible Electric

SFZ009e | SFZ009e Multi

The Invisible Electric range is designed for discreet and efficient transportation of refrigerated products in vans on electric power, both on road and during stand-by. A highly reliable battery-inverter package supplies the power, making the Invisible Electric an ideal choice for full-electric, hybrid, or conventional vehicles.

These units are installed underneath the vehicle chassis, completely invisible from the outside, preserving the aesthetics, original height and aerodynamics of the vehicle, while reducing bodywork. SFZ009e offers varying refrigeration capacities and volume ratings tuned for different applications. SFZ009e Multi features dual evaporators to enable products with different temperature requirements to be transported in two separate zones.

The Invisible range, with its ultra-thin dimensions make it the ideal choice for customers who need a space-saving solution. A driver-friendly interface in the cabin allows real-time monitoring and control of the unit performance to ensure the cargo is maintained at precisely the right temperature throughout the trip.

Key Features:

- ✓ Zero emissions
- ✓ Powered by reliable battery-inverter pack on road, chargeable on electric grid
- ✓ Compatible with full-electric, hybrid or conventional vehicles
- ✓ Multiple temperature zones in the same vehicle (Multi model only)
- ✓ Vehicle access to tight underground areas
- ✓ Under-chassis mounting preserves vehicle aesthetics and aerodynamics
- ✓ Invisible from the outside
- ✓ Low noise
- ✓ User-friendly cabin driver interface
- ✓ Telematics-compatible
- ✓ 2-year standard warranty



		SFZ009e	SFZ009e Multi		
General					
Refrigerant	[-]	R452A			
System net cooling capacity under ATP conditions (30°C ambient temperature)					
	[°C]	0°C	-20°C	0°C	-20°C
Battery mode	[W]	1900	1050	1760	970
Heating capacity					
Road mode	[W]	1650		1580	
Airflow rate					
Airflow rate at 100kPa static pressure	[m³/h]	840		2x 620	
Weight					
Condenser with electric stand-by	[kg]	75		75	
Evaporator	[kg]	20,5		2x 10,2	
Max current					
	[A]	165		170	

These products contain fluorinated greenhouse gases (R452A GWP=2140,5).
 Stand-by voltages available: 230/1/50 or 400/3/50
 Vehicle voltages available: 12VDC or 24VDC

Provisional engineering data

Zero Electric

Z120b

Z120b is powered by the vehicle battery, with minimal environmental impact and maximum cooling effectiveness ideal for refrigerated transport in vans. The unit can be installed quickly without any mechanical couplings with the vehicle engine, which also minimises power draw and thus emissions.

All Zero models provide easy installation and serviceability. The condensing unit can be mounted on the roof or the front wall of the box, and the ultra-thin evaporator installed in the cargo compartment maximizes cargo volume. A driver-friendly interface in the cabin allows real-time monitoring and control of unit performance to ensure goods are maintained at precisely the right temperature throughout the trip.

Key Features:

- ✓ Low emissions
- ✓ Proven reliability and performance
- ✓ Powered by vehicle battery on road, electric grid on stand-by
- ✓ Compatible with full-electric, hybrid or conventional vehicles
- ✓ Easy to install and service with removable side panels
- ✓ Low noise
- ✓ User-friendly cabin driver interface
- ✓ Reduced refrigerant charge and maintenance costs
- ✓ Telematics-compatible
- ✓ 2-year standard warranty, extendable up to 5 years

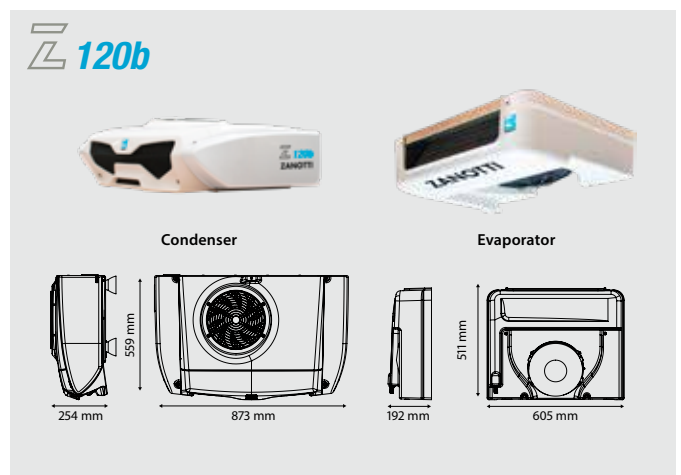

		Z120b	
General			
Refrigerant	[-]	R452A	
System net cooling capacity under ATP conditions (30°C ambient temperature)			
	[°C]	0°C	-20°C
Battery mode	[W]	1300	550
Heating capacity			
Road mode	[W]	1100	
Airflow rate			
Airflow rate at 100kPa static pressure	[m³/h]	560	
Weight			
Condenser with electric stand-by	[kg]	64	
Evaporator	[kg]	10,2	
Max current			
	[A]	75	

This product contains fluorinated greenhouse gases (R452A GWP=2140,5).

Stand-by voltages available: 230/1/50 or 400/3/50

Vehicle voltages available: 12VDC

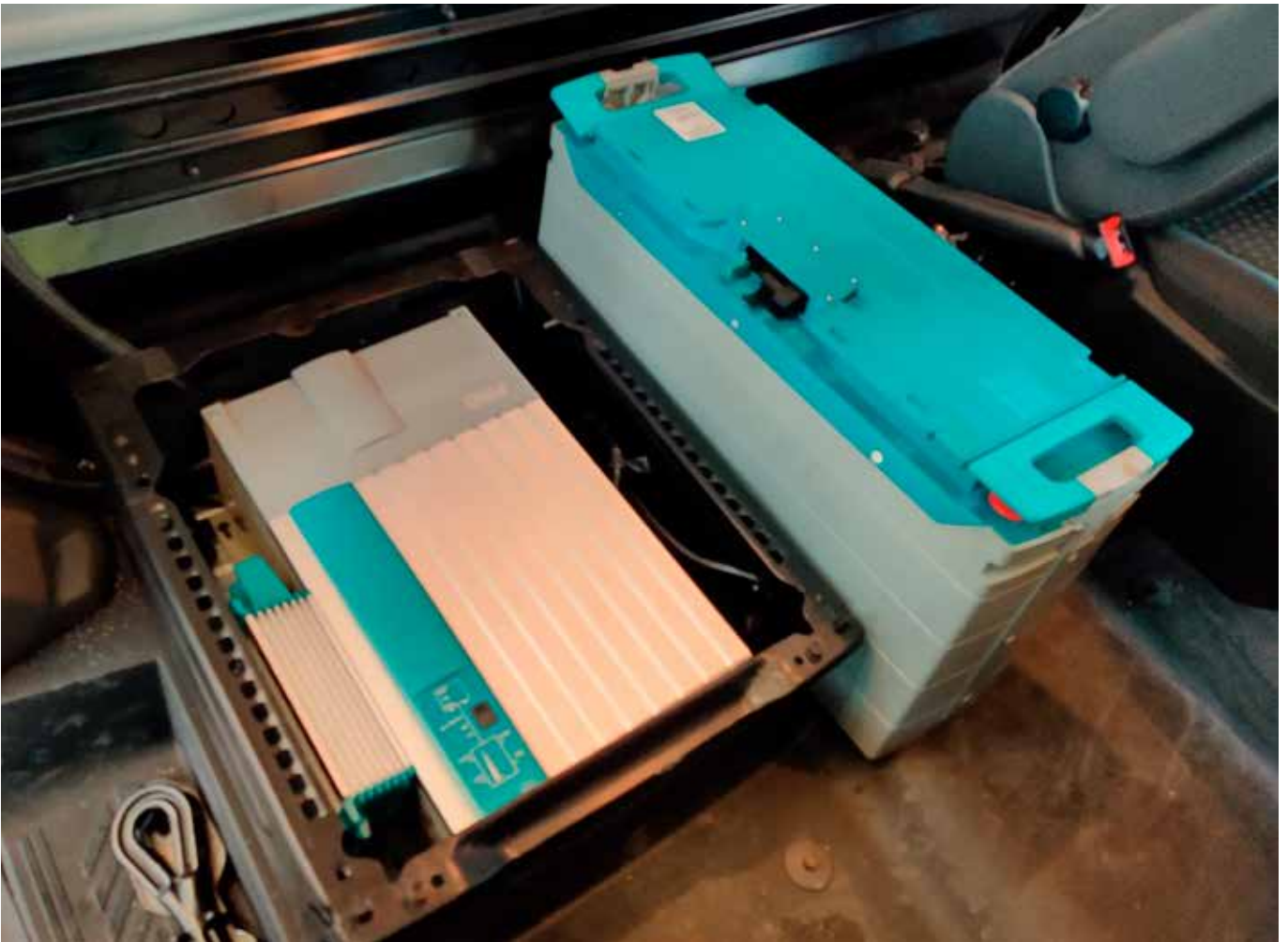

Electric Power Supply

Our power supply packages are designed to match our Invisible Electric and Zero Electric ranges, providing a high level of reliability and customization for the specific vehicle and application needs.

The power supply can be configured as one or two DC lithium-ion batteries, each providing 1,25 to 5,5kW, up to 11kW total; and comes with a robust inverter battery charger.

Key Features:

- ✓ Zero emissions
- ✓ Zero maintenance
- ✓ Automotive-grade design with high reliability
- ✓ Long life with 3500 cycles
- ✓ Fast charging
- ✓ 230VAC power for charging and stand-by operation
- ✓ Bluetooth connection with smartphone app
- ✓ Compatible with telematics, for remote battery monitoring
- ✓ Optional connection to vehicle DC battery for supplementary power supply
- ✓ Optional auxiliary input for external power supply



Battery Charger
Z120b only



Inverter Battery Charger
SFZ009e / Z200e / Z250e /
Z350e / Z350e Multi



Zero Electric

Z200e | Z250e | Z350e | Z350e Multi

The Zero range meets the needs of the distribution industry by offering the utmost flexibility in the temperature management of refrigerated products. Zero Electric is designed to meet a wide range of applications in light commercial vehicles on electric power, both on road and during stand-by. A highly reliable battery-inverter package supplies the power, making Zero Electric an ideal choice for full-electric, hybrid, or conventional vehicles.

Z200e, Z250e and Z350e offer varying refrigeration capacities and volume ratings tuned for different applications. Z350e Multi features additional evaporators to enable transport of products with different temperature requirements in separate zones.

All Zero models provide easy installation and serviceability. The condensing unit can be installed as top-mount on the roof of the box or nose-mount on the front wall of the box, and the ultra-thin evaporator installed in the cargo compartment maximizes cargo volume. A driver-friendly interface in the cabin allows real-time monitoring and control of unit performance to ensure goods are maintained at precisely the right temperature throughout the trip. Our Zero units are setting new standards with their attractive design.

Key Features:

- ✓ Zero emissions
- ✓ Powered by reliable battery-inverter pack on road, chargeable on electric grid
- ✓ Compatible with full-electric, hybrid or conventional vehicles
- ✓ Multiple temperature zones in the same vehicle (Multi model only)
- ✓ Proven reliability and performance
- ✓ Easy to install and service with removable side panels
- ✓ Low noise
- ✓ Configurable for a wide range of refrigerated applications in light commercial vehicles
- ✓ User-friendly cabin driver interface
- ✓ Reduced refrigerant charge and maintenance costs
- ✓ Telematics-compatible
- ✓ 2-year standard warranty



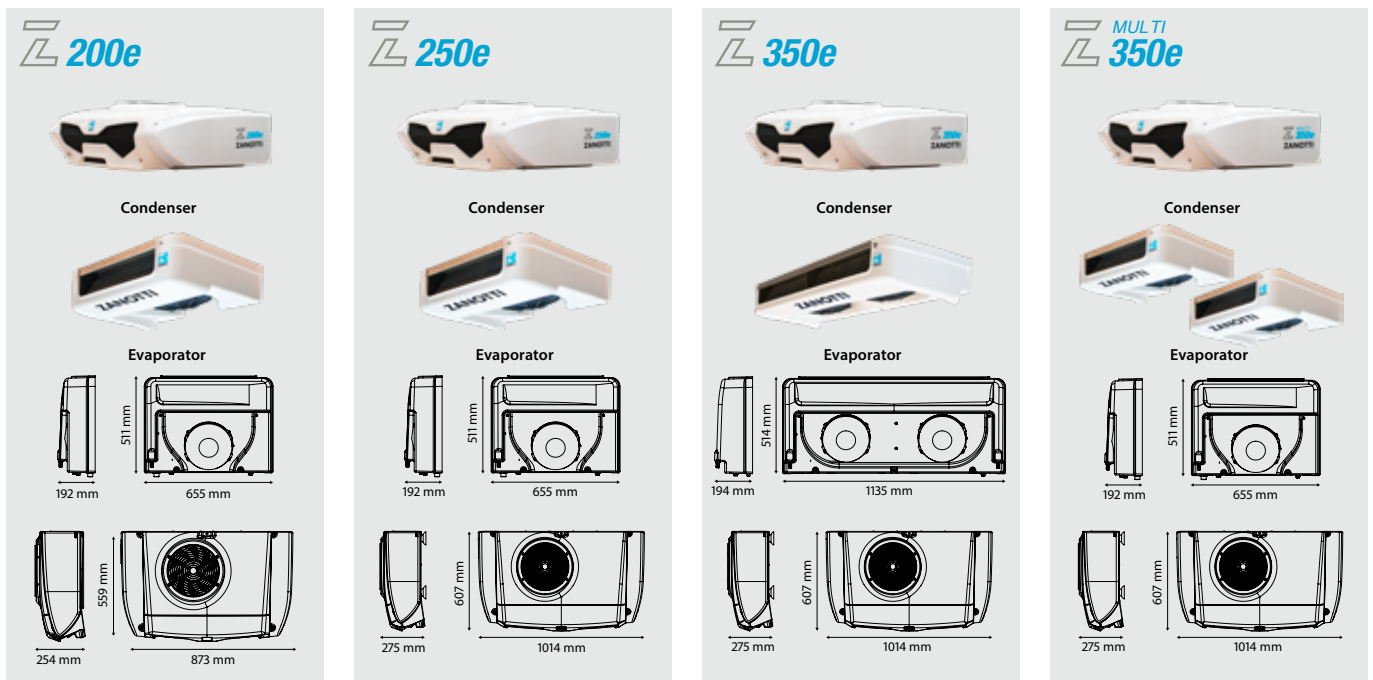

	Z200e	Z250e	Z350e	Z350e Multi					
General									
Refrigerant	[-] R452A								
System net cooling capacity under ATP conditions (30°C ambient temperature)									
	[°C]	0°C	-20°C	0°C	-20°C	0°C	-20°C	0°C	-20°C
Battery mode	[W]	1400	700	1700	800	1900	1150	1850	1100
Heating capacity									
Road mode	[W]	1200	1500	1650	1600				
Airflow rate									
Airflow rate at 100kPa static pressure	[m³/h]	620	650	1300	2x 620				
Weight									
Condenser with electric stand-by	[kg]	54	70	70	70				
Evaporator	[kg]	10,2	10,5	19,6	2X 10,2				
Max current									
	[A]	100	159	166	171				

These products contain fluorinated greenhouse gases (R452A GWP=2140,5).
 Stand-by voltages available: 230/1/50 or 400/3/50
 Vehicle voltages available: 12VDC or 24VDC

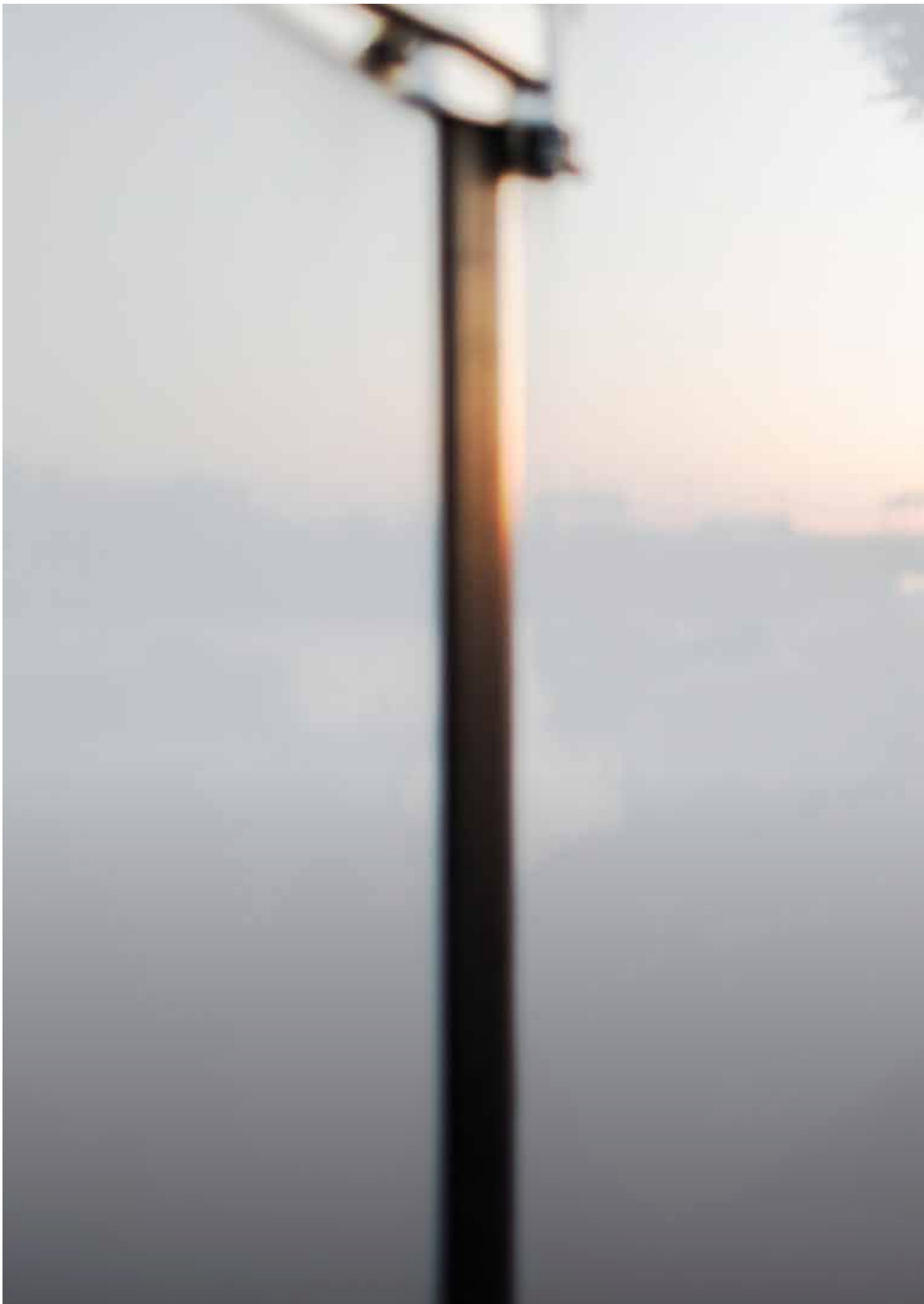

Light Truck





SFZ

SFZ238 | SFZ248

SFZ is a robust direct-drive solution for refrigerated transport on light to medium trucks. It is a proven design optimized for energy-efficiency, low noise, and easy-to-service transport of temperature-controlled goods in medium sized boxes.

SFZ238 and SFZ248 are designed as nose-mount, installed on the front wall of the box, with multiple configurations of evaporators and fans to meet the requirements of a wide range of vehicle types and applications. A driver-friendly interface in the cabin allows real-time monitoring and control of unit performance to ensure goods are maintained at precisely the right temperature throughout the trip.

Key Features:

- ✓ Proven reliability and performance
- ✓ Powered by direct-drive on road, electric grid on stand-by
- ✓ Easy to install and service, light weight
- ✓ Low noise
- ✓ Configurable for a wide range of refrigerated applications in light to medium trucks
- ✓ User-friendly cabin driver interface
- ✓ Telematics-compatible
- ✓ 2-year standard warranty





		SFZ238	SFZ248		
General					
Refrigerant	[-]	R452A			
System net cooling capacity under ATP conditions (30°C ambient temperature)					
	[°C]	0°C	-20°C	0°C	-20°C
Road mode	[W]	4700	2470	5200	2700
Stand-by mode	[W]	3830	2010	4350	2100
Heating capacity					
Road mode	[W]	3990		4540	
Stand-by mode	[W]	3310		2800	
Airflow rate					
Airflow rate at 100kPa static pressure	[m ³ /h]	1670		3340	
Weight					
Condenser without electric stand-by	[kg]	70		77	
Condenser with electric stand-by	[kg]	128		143	
Evaporator	[kg]	26,5		42,5	
Road compressor					
Displacement	[cc]	163		215	

These products contain fluorinated greenhouse gases (R452A GWP=2140,5).
 Stand-by voltages available: 230/1/50 or 400/3/50
 Vehicle voltages available: 12VDC or 24VDC

Provisional engineering data

SFZ Multi-Temp

SFZ238 Multi | SFZ248 Multi

Our SFZ Multi-Temp range is designed to meet the modern needs of refrigeration for light to medium trucks. These units feature additional evaporators to enable transport of products with different temperature requirements in separate zones, available in multiple configurations to adapt to a wide range of applications. It is a proven design optimized for energy-efficiency, low noise, and easy-to-service transport of temperature-controlled goods in medium-sized boxes.

SFZ238 Multi and SFZ248 Multi are designed as nose-mount, installed on the front wall of the box. A driver-friendly interface in the cabin allows real-time monitoring and control of unit performance to ensure goods are maintained at precisely the right temperature throughout the trip.

Key Features:

- ✓ Multiple temperature zones in the same vehicle
- ✓ Proven reliability and performance
- ✓ Powered by direct-drive on road, electric grid on stand-by
- ✓ Easy to install and service, lightweight
- ✓ Low noise
- ✓ Configurable for a wide range of refrigerated applications in light to medium trucks
- ✓ User-friendly cabin driver interface
- ✓ Telematics-compatible
- ✓ 2-year standard warranty

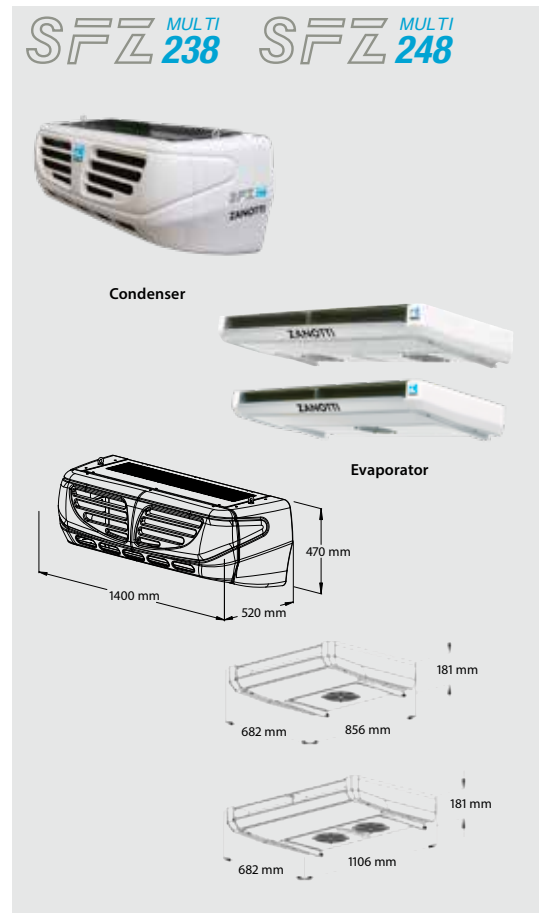

		SFZ238 Multi	SFZ248 Multi		
General					
Refrigerant	[-]	R452A			
System net cooling capacity under ATP conditions (30°C ambient temperature)					
	[°C]	0°C	-20°C	0°C	-20°C
Road mode	[W]	4430	2340	5080	2560
Stand-by mode	[W]	3710	1940	4130	2020
Heating capacity					
Road mode	[W]	3850		4430	
Stand-by mode	[W]	3230		3610	
Airflow rate					
Airflow rate at 100kPa static pressure	[m ³ /h]	2x 835		2x 1670	
Weight					
Condenser without electric stand-by	[kg]	70		77	
Condenser with electric stand-by	[kg]	128		143	
Evaporator	[kg]	2x		2x	
Road compressor					
Displacement	[cc]	163		215	

These products contain fluorinated greenhouse gases (R452A GWP=2140,5).

Stand-by voltages available: 230/1/50 or 400/3/50

Vehicle voltages available: 12VDC or 24VDC

Provisional engineering data

Truck





Uno

U600 | U800 | U1000

The redesigned Uno range of units are independently powered with a diesel engine, and available in various capacities to efficiently transport temperature-controlled products in medium to heavy trucks. The Uno features Zanotti's innovative direct coupling design between the engine and the compressor, and utilize Daikin's expertise in design for reliability and performance. Their high cooling performance, energy efficiency and extended maintenance intervals minimise the total cost of ownership, while meeting the most stringent emission, material waste, and noise pollution regulations.

U600, U800, and U1000 are designed as nose-mount, installed on the front wall of the box. All-new electronics enable advanced diagnostics and two-way telematics including remote monitoring and control. A robust interface in the cabin can be installed in the vehicle DIN slot or mounted on the dash, allowing real-time monitoring and control of unit performance to ensure goods are maintained at precisely the right temperature throughout the trip.

Key Features:

- ✓ Designed for high reliability with a custom Yanmar engine
- ✓ Innovative powertrain design enabling high performance and energy efficiency
- ✓ Reduced fuel consumption and noise
- ✓ Extended maintenance intervals
- ✓ All-new electronics compatible with two-way telematics
- ✓ 2-year standard warranty, extendable up to 5 years



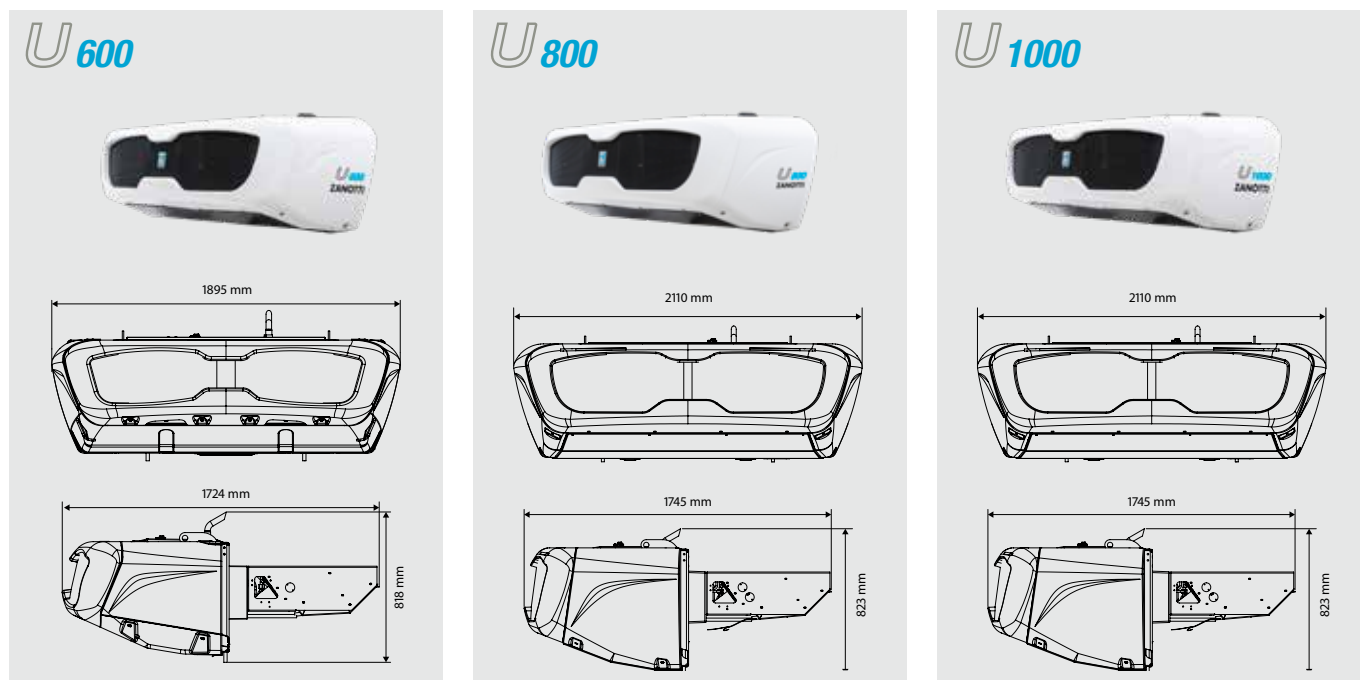

		U600	U800	U1000			
General							
Refrigerant	[-]	R452A					
Defrost	[-]	Hot gas defrost					
System net cooling capacity under ATP conditions (30°C ambient temperature)							
	[°C]	0°C	-20°C	0°C	-20°C	0°C	-20°C
Road mode	[W]	6200	3200	8600	4700	10000	5700
Stand-by mode	[W]	3700	1700	6500	3500	8300	4500
Heating capacity							
Road mode	[W]	5400		7500		8700	
Stand-by mode	[W]	3200		5700		7200	
Airflow rate							
Airflow rate at 100kPa static pressure	[m³/h]	1500		2200		2500	
Weight							
Monoblock road and stand-by	[kg]	485		500		549	
Monoblock road-only	[kg]	435		455		504	
Diesel engine							
Displacement	[cc]	854		1116		1116	
Rated power output	[kW]	11,5		15,1		15,1	
Maintenance interval	[hrs]	2000		2000		2000	
Road compressor							
Displacement	[cc]	235		325		390	
Stand-by compressor							
Displacement	[m³/h]	11,3		14,4		21,4	

These products contain fluorinated greenhouse gases (R452A GWP=2140,5).
Stand-by voltages available: 400/3/50



Uno

U800 Multi | U1000 Multi

The redesigned Uno range of units are independently powered with a diesel engine, and available in various capacities to efficiently transport temperature-controlled products in medium to heavy trucks. The Uno features Zanotti's innovative direct coupling design between the engine and the compressor, and utilize Daikin's expertise in design for reliability and performance. Their high cooling performance, energy efficiency and extended maintenance intervals minimise the total cost of ownership, while meeting the most stringent emission, material waste, and noise pollution regulations.

U800 Multi and U1000 Multi are designed as nose-mount, installed on the front wall of the box, with multiple configurations of evaporators and fans to meet the requirements of a wide range of vehicle types and applications. All-new electronics enable advanced diagnostics and two-way telematics including remote monitoring and control. A robust interface in the cabin can be installed in the vehicle DIN slot or mounted on the dash, allowing real-time monitoring and control of unit performance to ensure goods are maintained at precisely the right temperature throughout the trip.

Key Features:

- ✓ Multiple temperature zones in the same vehicle
- ✓ Designed for high reliability with a custom Yanmar engine
- ✓ Innovative powertrain design enabling high performance and energy efficiency
- ✓ Reduced fuel consumption and noise
- ✓ Extended maintenance intervals
- ✓ All-new electronics compatible with two-way telematics
- ✓ 2-year standard warranty, extendable up to 5 years



The all-new Uno cabin controller is modern technology in a robust build.

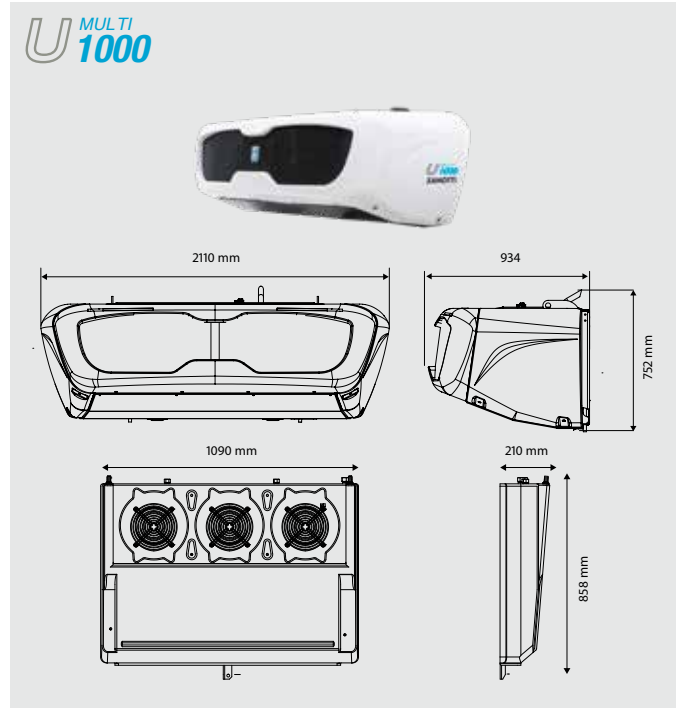
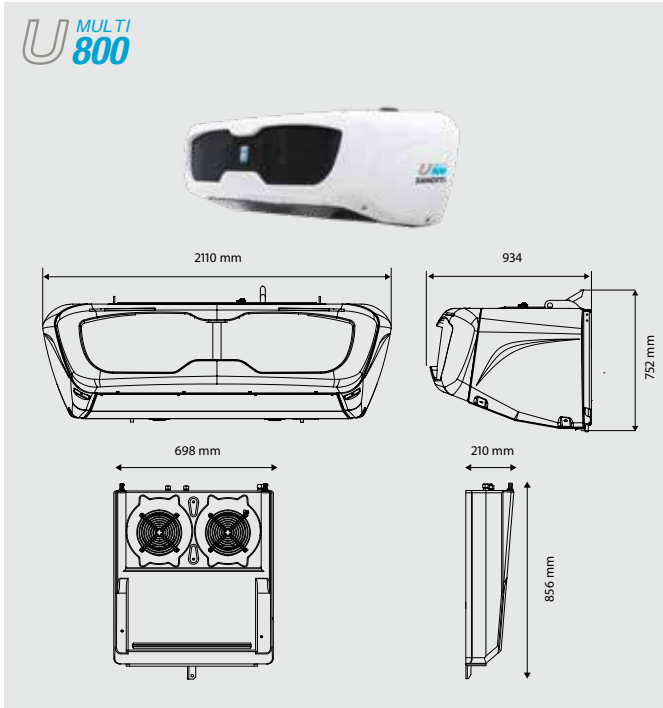

	U800 Multi		U1000 Multi		
General					
Refrigerant	[-]	R452A			
Defrost	[-]	Hot gas defrost			
System net cooling capacity under ATP conditions (30°C ambient temperature)					
	[°C]	0°C	-20°C	0°C	-20°C
Road mode	[W]	8400	4200	9800	5400
Stand-by mode	[W]	5600	2900	8700	4500
Heating capacity					
Road mode	[W]	7300		8500	
Stand-by mode	[W]	4900		7600	
Airflow rate					
Airflow rate at 100kPa static pressure	[m³/h]	2x 1680		2x 2520	
Weight					
Split road and stand-by	[kg]	500		505	
Monoblock road-only	[kg]	460		465	
Evaporator	[kg]	35 x 2		40 x 2	
Diesel engine					
Displacement	[cc]	1116		1116	
Rated power output	[kW]	13,2		13,2	
Maintenance interval	[hrs]	2000		2000	
Road compressor					
Displacement	[cc]	325		390	
Stand-by compressor					
Displacement	[m³/h]	14,4		21,4	

These products contain fluorinated greenhouse gases (R452A GWP=2140,5).
Stand-by voltages available: 400/3/50

Uno Undermount

UN120 | UN120 Multi

Uno Undermount models are independently powered with a diesel engine, and available in various capacities to efficiently transport temperature-controlled products in heavy trucks. The units feature Zanotti's innovative direct coupling design between the engine and the compressor.

UN120 and UN120 Multi are undermount units designed to be installed under the box. UN120 Multi features additional evaporators to enable transport of products with different temperature requirements in separate zones. A driver-friendly interface in the cabin enables them to monitor and modify performance to ensure it is kept at precisely the right temperature throughout the trip.

Key Features:

- ✓ Multiple temperature zones in the same vehicle (Multi model only)
- ✓ Designed for high reliability with a custom Yanmar engine
- ✓ Innovative powertrain design enabling high performance and energy efficiency
- ✓ Reduced fuel consumption and noise
- ✓ Telematics-compatible
- ✓ 2-year standard warranty

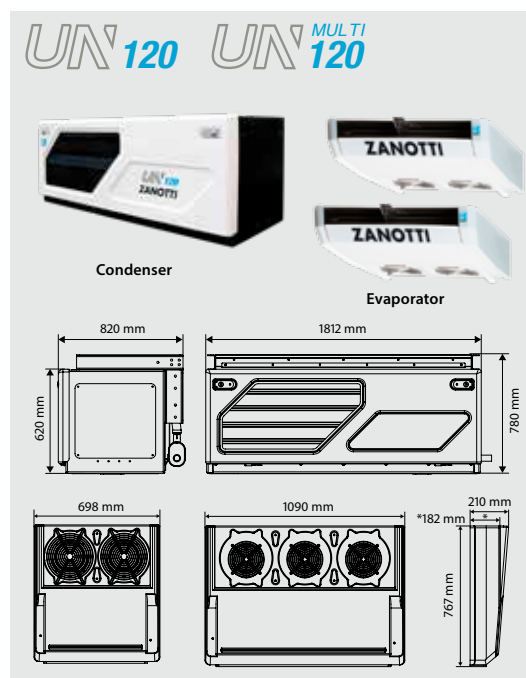

		Un120	Un120 Multi		
General					
Refrigerant	[-]	R452A			
Defrost	[-]	Hot gas defrost			
System net cooling capacity under ATP conditions (30°C ambient temperature)					
	[°C]	0°C	-20°C	0°C	-20°C
Road mode	[W]	11500	6200	10600	5700
Stand-by mode	[W]	8200	4200	7500	3900
Heating capacity					
Road mode	[W]	10000		9500	
Stand-by mode	[W]	7100		6700	
Airflow rate					
Airflow rate at 100kPa static pressure	[m³/h]	4500		2x 2520	
Weight					
Condensing unit road and stand-by	[kg]	510		510	
Condensing unit road-only	[kg]	475		475	
Evaporators	[kg]	40		40 x 2	
Diesel engine					
Displacement	[cc]	1116		1116	
Rated power output	[kW]	13,2		13,2	
Maintenance interval	[hrs]	2000		2000	
Road compressor					
Displacement	[cc]	390		390	
Stand-by compressor					
Displacement	[m³/h]	21,4		21,4	

These products contain fluorinated greenhouse gases (R452A GWP=2140,5).
Stand-By voltages available: 400/3/50

A close-up photograph of a technician working on a mechanical system. The technician is wearing blue safety goggles and blue gloves. He is holding a yellow hose connected to a copper pipe. The background is blurred, showing more of the mechanical system and some orange and blue elements. A semi-transparent blue box is overlaid on the top right of the image, containing the text "Service & Aftermarket" in white.

Service & Aftermarket

Service Network

Our extensive European service network is your partner for piece of mind, with maintenance and repair available 24/7. We are continuously growing our service capability to meet the needs of our customers.



Genuine Parts

Zanotti genuine parts are engineered to ensure maximum performance and reliability throughout the lifetime of your product. Using genuine parts is the only way to protect your investment under Daikin warranty and minimise total cost of ownership. In comparison tests, our genuine replacement parts exceed the results obtained from third-party spare parts.



Key benefits of using genuine replacement parts:

- ✓ No performance compromises
- ✓ The highest quality standards
- ✓ Guaranteed fit, reliability, and safety
- ✓ Maintain peak efficiency
- ✓ Lower total cost of ownership
- ✓ Ensure the warranty of your product

Extended Warranty

All our transport refrigeration units come standard with a two-year warranty. For those wanting even greater peace of mind and ease of ownership, extended warranties of three, four and five years are also available.



Telematics

Zanotti Telematics can help fleet managers gain greater control and insight over their van and truck fleets remotely. The back-end of our system is supported by an EU-based provider highly experienced in commercial vehicle telematics, and enables worldwide connectivity via mobile network technology. GDP-compliant data logging equipment meets the regulatory requirements for refrigerated transport of pharmaceutical goods.

Our Standard Telematics package is a comprehensive offering for vehicle and refrigeration, available as an option on all Zanotti units. The Expert package includes two-way communications designed for fleets that need remote control over the refrigeration units, currently available on our select units only. Additional pharma features take the Standard and Expert to meet the requirements of the pharma industry.

Our telematics framework is designed with the customer in mind, providing the utmost flexibility by being available for Zanotti and third-party refrigeration units, either as brand-new or retrofit; and configurable for third-party fleet management software or logistics systems.

	Standard	Expert ⁽¹⁾	Pharma	Expert Pharma ⁽¹⁾
Intuitive online fleet management portal	X	X	X	X
Compatible with most third-party van and truck refrigeration units ⁽²⁾	X	X	X	X
Configurable for most third-party fleet management software and logistics systems ⁽²⁾	X	X	X	X
Live location monitoring on map	X	X	X	X
Temperature setpoint and return air temperature reading per refrigerated zone	X	X	X	X
1-year history on location and temperature data stored on the cloud	X	X	X	X
Alarms with push notification on web server	X	X	X	X
Unplanned door opening alarm		X		X
Vehicle anti-theft alarm		X		X
Geofence alarm programming		X		X
Remote power on/off		X		X
Remote setpoint control		X		X
Remote alarm reset		X		X
GDP-compliant datalogger			X	X
Real-time temperature data transfer			X	X
Emailing of temperature logs to recipient			X	X
Annual temperature sensor calibration			X	X



⁽¹⁾ Available on select Zero and Uno units

⁽²⁾ Verify compatibility before purchase

Home Delivery Solutions

“Our years-long partnership with Zanotti is because of their agility in responding to our ever-changing needs.”

– Leading food retail chain

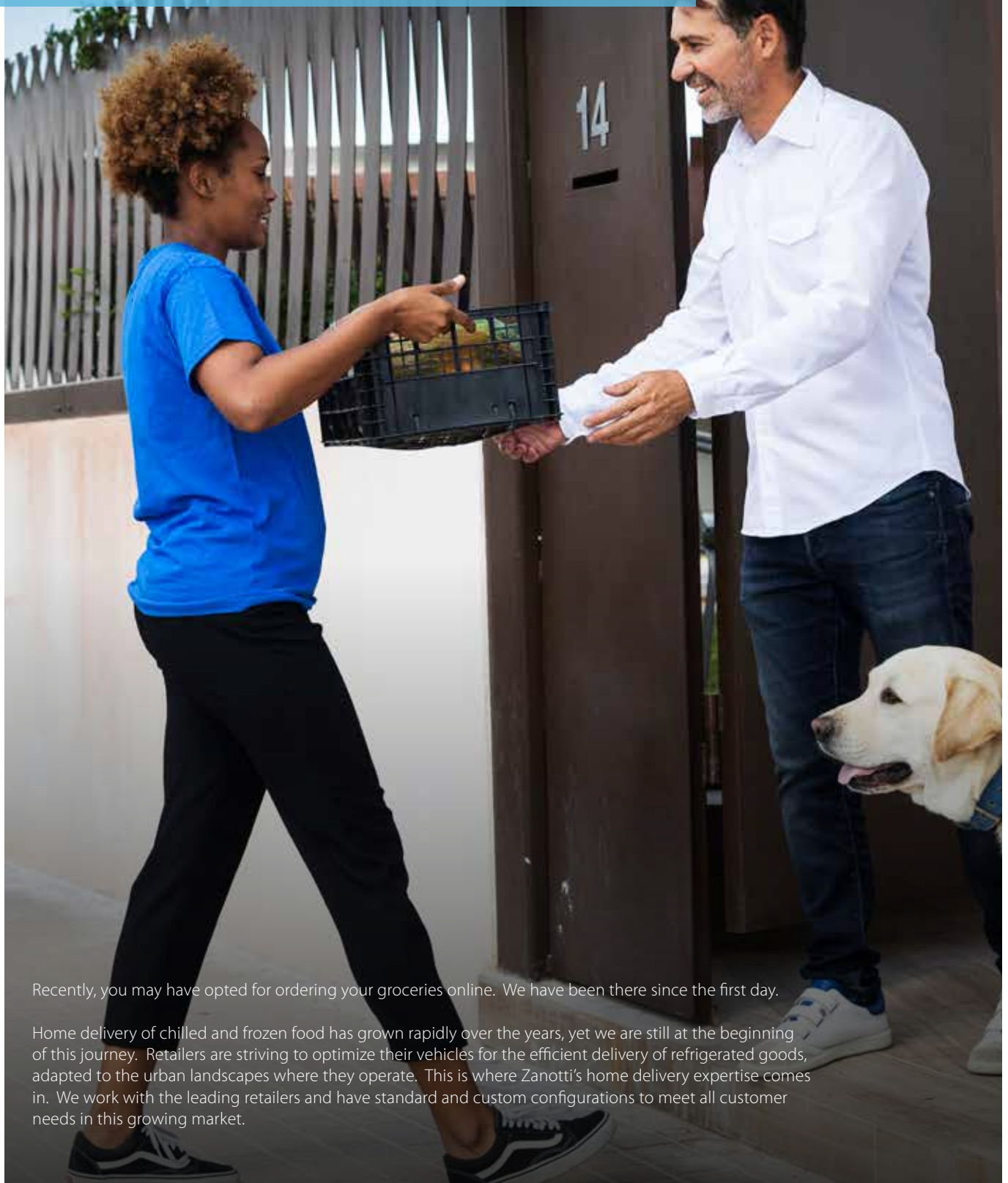

Recently, you may have opted for ordering your groceries online. We have been there since the first day.

Home delivery of chilled and frozen food has grown rapidly over the years, yet we are still at the beginning of this journey. Retailers are striving to optimize their vehicles for the efficient delivery of refrigerated goods, adapted to the urban landscapes where they operate. This is where Zanotti's home delivery expertise comes in. We work with the leading retailers and have standard and custom configurations to meet all customer needs in this growing market.

Pharma Solutions

"Zanotti's unique Invisible product line enables us to efficiently manage the last-mile delivery of our precious cargo."

– Pharma logistics service provider

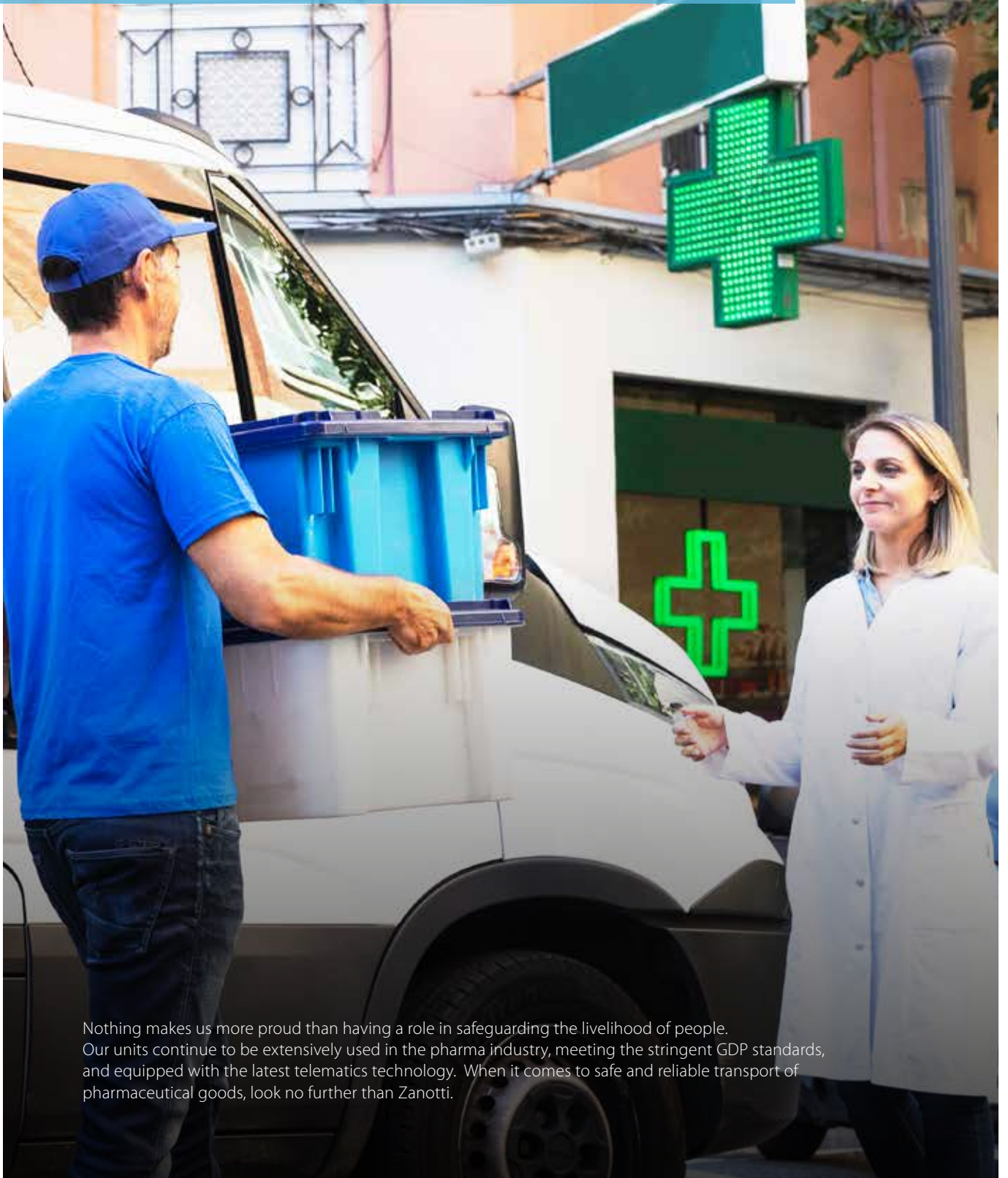

Nothing makes us more proud than having a role in safeguarding the livelihood of people. Our units continue to be extensively used in the pharma industry, meeting the stringent GDP standards, and equipped with the latest telematics technology. When it comes to safe and reliable transport of pharmaceutical goods, look no further than Zanotti.

Future of Daikin Transport Refrigeration



Technology Innovation Center

We are building a new Technology Innovation Center for Refrigeration, adjacent to our Zanotti factory in Mantua, Italy. This is a unique collaborative research and development facility with testing for the entire refrigeration range. Within its walls are a wide array of laboratories, training rooms, and testing equipment designed to put every new product through a rigorous series of tests, including our special 3-axial hydrodynamic vibration, salt spray corrosion, and sound tests. All products are tested in order to meet our strict quality, efficiency, and environmental standards.



In Daikin, our philosophy is to anticipate the future needs of our customers, and continuously invest to stay ahead of a constantly evolving market. Every five years we advance our long-term strategy to a new "Fusion" plan and we stay on course to deliver our commitments.

We are at the crossroads where the Transport Refrigeration industry will undergo dramatic changes, accelerated by macro trends including climate change, urbanisation, internet of things (IoT), food waste, and the unprecedented global challenge posed by the Covid-19 pandemic.

With our family of brands working as one to provide cold chain solutions, we relish the responsibility to once again take the lead and bring innovation into the Transport Refrigeration industry.



Daikin Production System

Daikin is an expert in mass production with over 100 factories around the world delivering the highest level of reliability, recognized by numerous awards over the years. We are reengineering our Zanotti production facilities to deliver the full range of refrigeration units with exceptional quality, customisation and shorter lead-times.



Cold Chain Synergy

As a cold chain solution provider globally, we imagine a future where road transport is not a standalone segment of the refrigeration industry but seamlessly integrated into the overall system of cold chain, from farm to fork. Having access to a wide span of technologies through our family of brands enables us to innovate and provide new solutions to global challenges including the safe transport of pharmaceuticals including remote locations; and food authenticity, traceability and waste reduction.

We take our role in the sustainability of the cold chain seriously, and there is so much more to come. Follow us on <https://www.linkedin.com/company/daikin-europe-nv/>



Discover our Transport Refrigeration Portfolio
Daikin.eu/transportrefrigeration

Daikin Europe N.V. Naamloze Vennootschap Zandvoordestraat 300 · 8400 Oostende · Belgium · www.daikin.eu · BE 0412 120 336 · RPR Oostende (Responsible Editor)

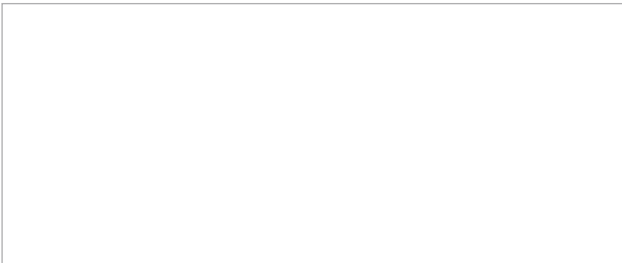

ECPEN20-860

10/2020



The present publication is drawn up by way of information only and does not constitute an offer binding upon Daikin Europe N.V. Daikin Europe N.V. has compiled the content of this publication to the best of its knowledge. No express or implied warranty is given for the completeness, accuracy, reliability or fitness for particular purpose of its content and the products and services presented therein. Specifications are subject to change without prior notice. Daikin Europe N.V. explicitly rejects any liability for any direct or indirect damage, in the broadest sense, arising from or related to the use and/or interpretation of this publication. All content is copyrighted by Daikin Europe N.V.